

# Series CEU Series CE Counter/Extension Cable



## ■ Multi-counter

### How to Order



Note) CE-compliant: When connecting to a stroke reading cylinder (CE1), a high precision stroke reading cylinder (CEP1) and a stroke reading cylinder with brake (CE2). (CEU5□□-D type)  
Refer to the operation manual for details.

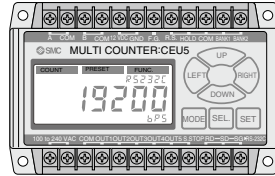
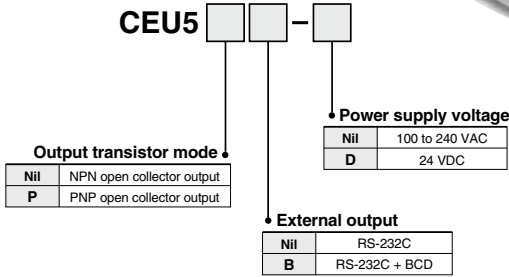

## Connection Method

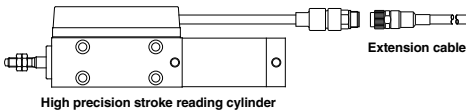

If the distance between high precision stroke reading cylinder and multi-counter is over 23 meter, use transmission box. (CE1-H0374)  
When changing the wiring combination of White-A/Blue-COM and Yellow B/Brown-COM to the combination of White B/Blue-COM and Yellow-A/Brown-COM, the counting direction reverses.

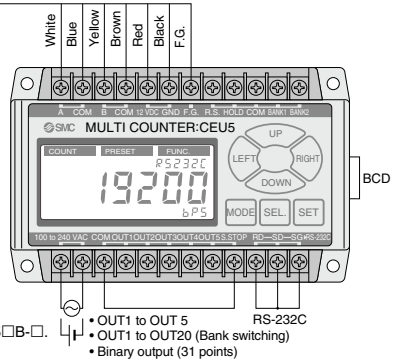

- BCD output (Refer to page 1628.) function is available only for CEU5□□-□.
- (1) BCD output connector: D-Sub half pitch connector  
(Built in CEU5□□B-D) D x 10M-36S (Made by Hirose Electric Co., Ltd.)
  - (2) Applicable connectors: D x 30AM-36P (Plug: Made by Hirose Electric Co., Ltd.) \*  
D x 30M-36-CV (Cover: Made by Hirose Electric Co., Ltd.) \*  
Other interchangeable commercial cables with connectors can be also used.

\* Pressure welding tools are required to connect the connector (plug, cover) models listed above and cables (order separately). The following products, including pre-assembled connectors and cables, are also available. Contact the manufacturer (Misumi Corporation) directly.  
SHPT-H-36-L (length): Cable with separate lines on one end  
SHPT-HH-36-L (length): Cable with BCD connectors (male) on both ends

CEP1

CE1

CE2

ML2B

D-□

-X□

## Multi-counter/Specifications

Model	CEU5	CEU5-D	CEU5P	CEU5P-D	CEU5B	CEU5B-D	CEU5PB	CEU5PB-D
Type	Multi-counter							
Mounting	Surface mounting (DIN rail or Screw stop)							
Operating system	Adding - subtracting type							
Operation mode	Operating mode, Data setting mode, Function setting mode							
Reset system	External reset terminal							
Display system	LCD (With back light)							
Number of digits	6 digits							
Memory holding (Storage medium)	Setting value (always held), Count value (Hold/Non-hold switching), (E <sup>2</sup> ROM (Warning display after writing approx. 800,000 times: E2FUL))							
Input signal type	Count input, Control signal input (Reset, Hold, Bank selection)							
Count input	No-voltage pulse input							
Pulse signal system	90° phase difference input *1/ UP/DOWN separate input *2							
Counting speed	100 kHz *1							
Control signal input	Voltage input (12 VDC or 24 VDC)							
Sensor power supply	10.8 to 13.2 VDC, 60 mA							
Output signal type	Preset output, Cylinder stop output				Preset output, Cylinder stop output, BCD output			
Preset output configuration	Compare/Hold/One-shot (100 ms fixed pulse)							
Output type	Separate 5 point output/Binary code output							
Output delay time	5 ms or less (for normal output)/60 ms or less (Binary output)							
Communication system	RS-232C							
Output transistor mode	NPN open collector Max 30 VDC, 50 mA		PNP open collector Max 30 VDC, 50 mA		NPN open collector Max 30 VDC, 50 mA *3		PNP open collector Max 30 VDC, 50 mA *3	
Power supply voltage	90 to 264 VAC	21.6 to 26.4 VDC	90 to 264 VAC	21.6 to 26.4 VDC	90 to 264 VAC	21.6 to 26.4 VDC	90 to 264 VAC	21.6 to 26.4 VDC
Power consumption	20 VA or less	10 W or less	20 VA or less	10 W or less	20 VA or less	10 W or less	20 VA or less	10 W or less
Withstand voltage	Between case and AC line: 1500 VAC for 1 min. Between case and signal ground: 500 VAC for 1 min.							
Insulation resistance	Between case and AC line: 50 MΩ or more (500 VDC measured via megohmmeter)							
Ambient temperature	0 to +50°C (No freezing)							
Ambient humidity	35 to 85% RH (No condensation)							
Noise resistance	Square wave noise from a noise simulator (pulse duration 1 μs) between power supply terminals ±2000 V, I/O line ±600 V							
Shock resistance	Endurance 10 to 55 Hz; Amplitude 0.75 mm; X, Y, Z for 2 hours each							
Impact resistance	Endurance 10 G; X, Y, Z directions, 3 times each							
Weight	350 g or less							

\*1) 90° phase difference input

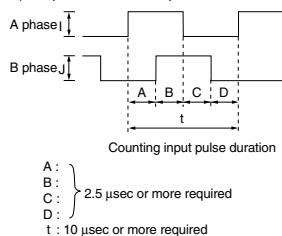

$$\text{Counting speed } f = \frac{1}{t} = \frac{1}{10 \times 10^{-6}} = 100000 \text{ Hz} \approx 100 \text{ kHz}$$

\*2) UP/DOWN input

Input wave form conditions: At a maximum of 100 kHz, the UP/DOWN wave form should be as shown below.

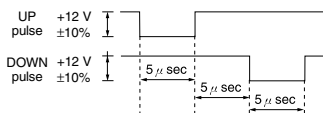

\*3) 15 mA when BCD is output (Refer to page 1630.)

## Multi-counter/Dimensions

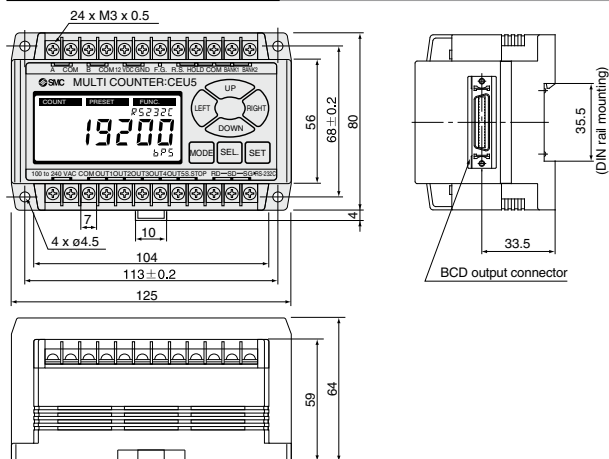

## Wiring with External Equipment

### <Wiring with multi-counter CEU5>

#### 1. Wiring of power source for driving counter

For power source for driving counter, use the one with 90 to 264 VAC, 50/60 Hz or 21.6 to 26.4 VDC, 0.4 A or more.

#### 2. Wiring for control signal input

(Selection among Reset, Hold, Bank (Refer to page 1628.)) Make each control signal to be the transistor which can run more than 15 mA or the contact output. Input time for reset signal should be more than 10 ms. Bank (Refer to page 1628.) selection and hold will function only when the input signal is applied.

COM is common to each signal input. Applicable to NPN and PNP input. Use 24 VDC or 12 VDC for the power source of COM. Connect DC- when PNP is applied, and DC+ when NPN is applied.

CEU5 Control signal input

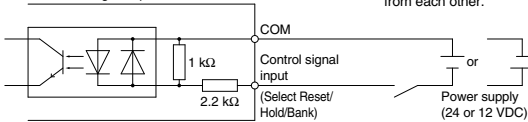

#### 3. Output circuit

There are two outputs, the NPN open collector and the PNP open collector.

The maximum rating is 30 VDC, 50 mA. Operating the controller by exceeding this voltage and amperage could damage the electric circuit.

Therefore, the equipment to be connected must be below this rating.

Model	CEU5□-□	CEU5P□-□
Connection method	NPN transistor output 	PNP transistor output 

\* However, the COM of the input circuit and the COM of the output circuit are electrically insulated from each other.

CEP1

CE1

CE2

ML2B

D-□

-X□

## CEU5 Operation

### Parts description

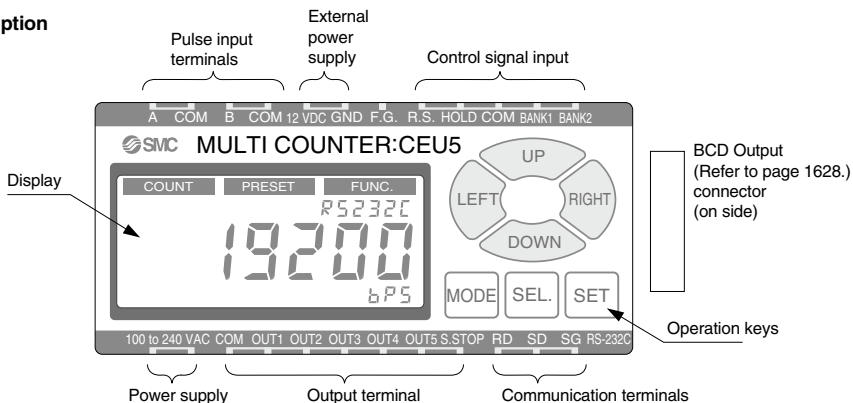

### Display detail

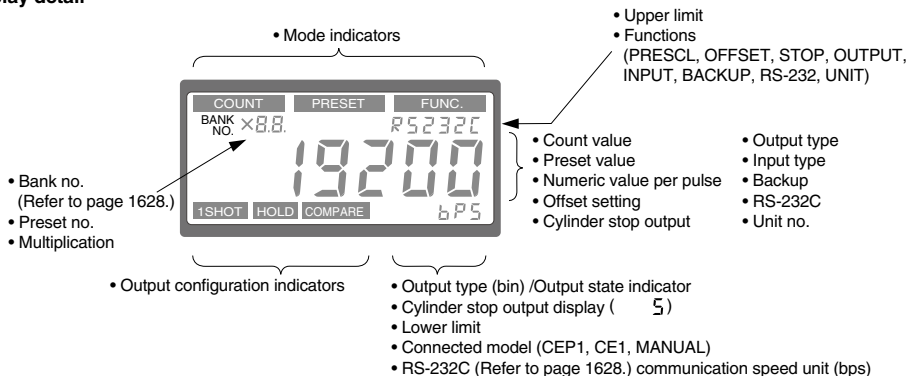

### Key and Functions

Key	Functions
MODE	Changes the mode. In any given condition, it shifts to the next mode. Does not write data.
SEL.	Shifts the cursor to the next item. Does not write data.
SET	Writes displayed data into the memory when setting.
RIGHT	Shifts the cursor to the right when setting numerical values.
LEFT	Shifts the cursor to the left when setting numerical values.
UP	Changes the contents of a setting. Increases the value when setting numerical values.
DOWN	Changes the contents of a setting. Decreases the value when setting numerical values.

In the explanations of the operating method, references to "Direction keys" indicate the 4 keys RIGHT, LEFT, UP and DOWN.

Mode cycle using mode key

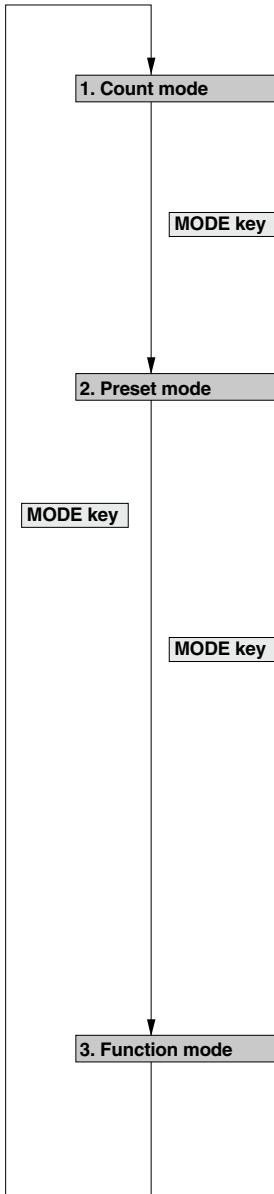

**Basic Operation**

- **SET key** : In any of the conditions (1) through (5), this writes the display data into the memory and shifts to (1).
- **SEL. key** : Shifts to the next item, but does not write data.
- **MODE key** : In any given condition, this shifts to the next mode, but does not write data.
- **Direction keys** : LEFT/RIGHT keys shift the digits, and UP/DOWN keys increase or decrease numerical values.

**1. Explanation of display in count mode**

**Normal output display**

Displays current output bank (Refer to page 1628).



Displays output state of each OUT terminal

**Binary output display**

Displays only when matched with preset

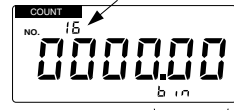

Display of binary output selection.

**2. Setting of preset mode**

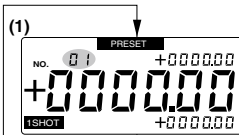

**Selection of preset No.**

- Select a preset number from 1 to 31 with the UP/DOWN keys.
- Shift to the next item with the SEL. key.

SEL. key



**Setting the preset values**

- Shift the digits with the LEFT/RIGHT keys, and increase or decrease the numerical values with the UP/DOWN keys.
- Shift to the next item with the SEL. key.

SEL. key



**Setting the upper limit tolerance**

- Set numerical values in the same way with the direction keys.
- When ± is selected, the lower limit display is cleared and ± setting is possible.
- Shift to the next item with the SEL. key.

SEL. key



**Setting the lower limit tolerance**

- Set numerical values in the same way with the direction keys.
- When ± is selected in the upper limit setting, this item is not displayed.
- Shift to the next item with the SEL. key.

SEL. key



**Setting the output configuration**

- Switch to 1SHOT, HOLD or COMPARE with the UP/DOWN keys.
- Store the setting with the SET key.
- The SEL. key only shifts to another item without storing the setting.

SET. key

CEP1

CE1

CE2

ML2B

D-□

-X□

## CEU5 Operation

### 3. Explanation of settings in the function mode

If the UP/DOWN keys are pressed when an item name is flashing, it shifts to another setting item. When the SEL. key is pressed, the cursor shifts and it is possible to change the content of the setting for the item which is being displayed.

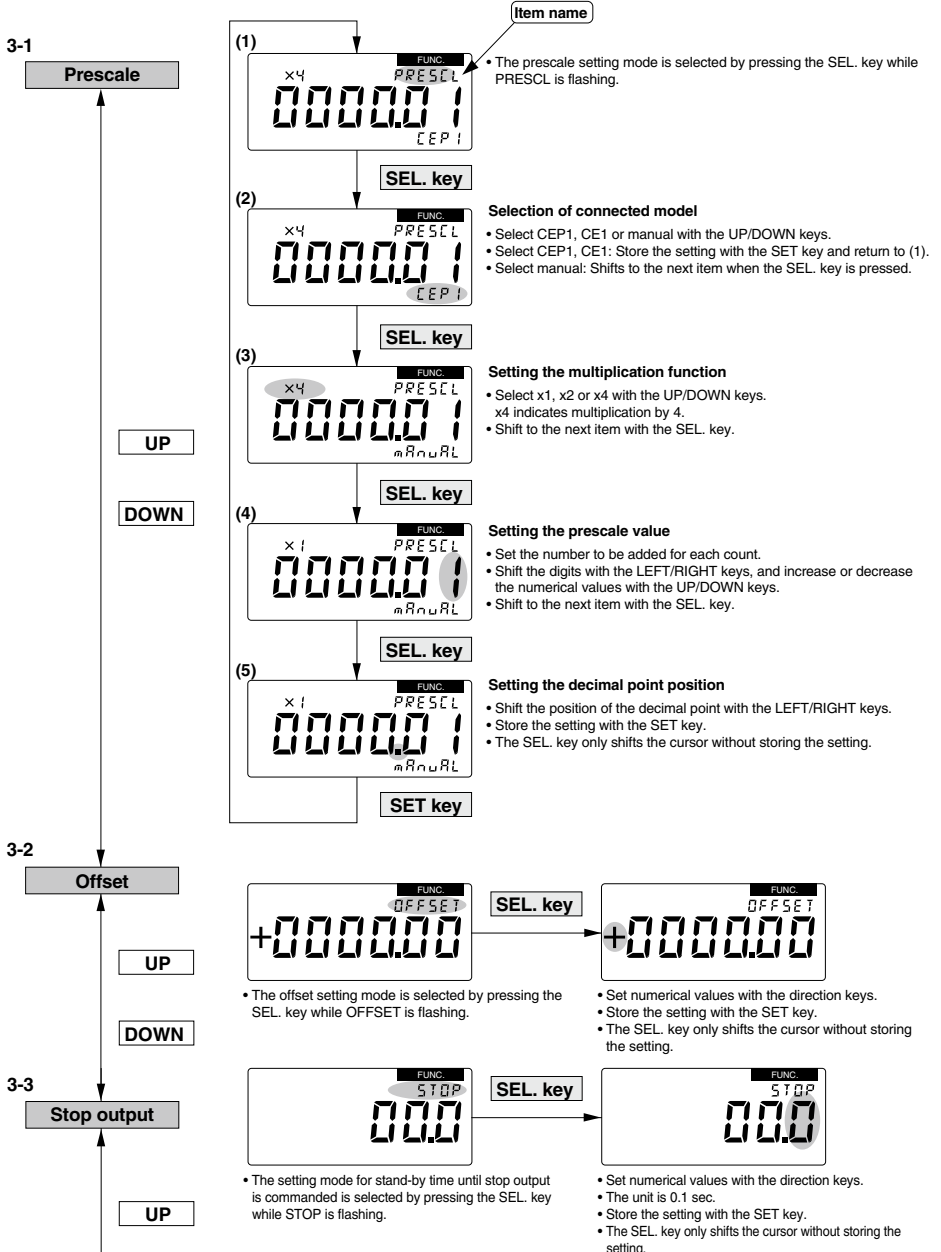

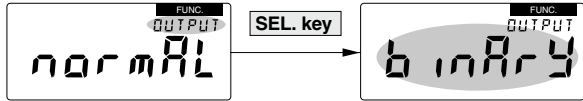
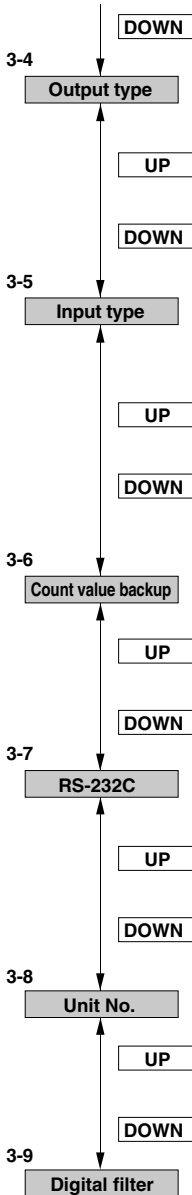

• The output system setting mode is selected by pressing the SEL. key while OUTPUT is flashing.

- Select normal output or binary output with the UP/DOWN keys.
- Store the setting with the SET key.
- The SEL. key only shifts the cursor without storing the setting.

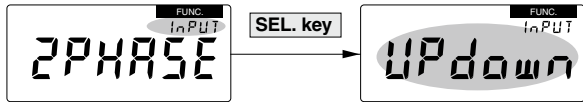

• The input type setting mode is selected by pressing the SEL. key while INPUT is flashing.

- Select phase difference input with the UP/DOWN keys, (±2PHASE) or separate input (±UP/DOWN) with the UP/ DOWN keys.
- If the polarity changes, the count direction reverses.

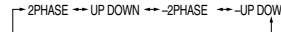

- Store the setting with the SET key.
- The SEL. key only shifts the cursor without storing the setting.

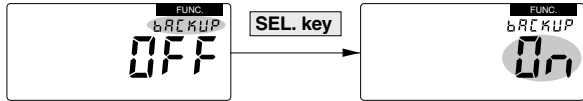

• The count value backup setting mode is selected by pressing the SEL. key while BACKUP is flashing.

- Select ON or OFF with the UP/DOWN keys.
- Store the setting with the SET key.
- The SEL. key only shifts the cursor without storing the setting.

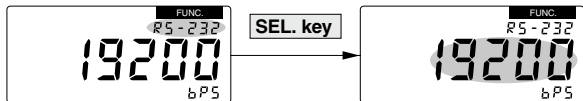

• The RS-232C (Refer to page 1628.) communication speed setting mode is selected by pressing the SEL. key while RS-232 is flashing.

- Select the communication speed from 1200, 2400, 4800, 9600 or 19200 with the UP/DOWN keys.
- Store the setting with the SET key.
- The SEL. key only shifts the cursor without storing the setting.

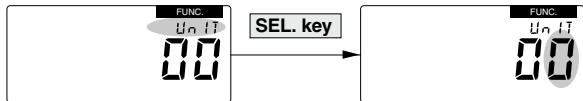

• The unit number registration mode is selected by pressing the SEL. key while UNIT is flashing.

- Set numerical values with the direction keys.
- Settings can be made from 00 to 99.
- Store the setting with the SET key.

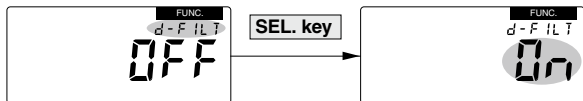

- Select ON or OFF with the UP/DOWN key.
- Store the setting with the SET key.

Note) When the digital filter setting (ON/OFF) is changed, an error count will occur. Reset the count value.

CEP1  
CE1  
CE2  
ML2B

D-□  
-X□

# Glossary (Functions of CEU5)

## BCD Output

This is a system which expresses one digit of a decimal number with a 4 digit binary number.  
The count value is expressed by the ON/OFF state of each BCD output terminal. In the case of 6 digits, 24 terminals are required.

The relation between decimal numbers and BCD codes is shown in the table below.

Decimal no.	0	1	2	3	4	5	6	7	8	9
BCD	0000	0001	0010	0011	0100	0101	0110	0111	1000	1001

Ex.) 1294.53 is expressed as follows.  
0001 0010 1001 0100 0101 0011

## RS-232C

This is the interface standard for the serial transmission method, which is standard equipment on a personal computer.

## Prescale Function

This function allows free setting of how many millimeters will indicate one pulse.

## Binary Output

31 point preset output is possible without bank switching, by means of binary system output from a 5 point output terminal. Cylinder stop output is used as the readout release signal.

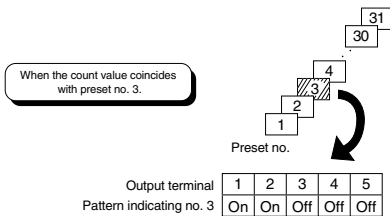

The coincident preset number is expressed as a 5 digit binary number.

## Bank Function

5 points of preset output are possible simultaneously, however, a maximum of 20 types of work discrimination, etc. can be performed by using the 5 points of preset values as one of a maximum of four quadrats, and switching its use during operation.

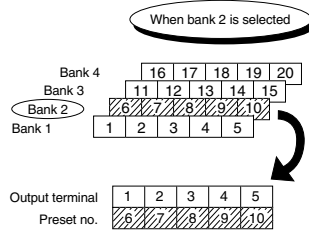

For example, when bank 2 is selected, presets 6 through 10 are valid and when the count value coincides with the setting value of 6 through 10, the respective output terminals 1 through 5 are turned ON.

## Bank Switching Correspondence

Input terminal / Bank no.	BANK2	BANK1
1	OFF	OFF
2	OFF	ON
3	ON	OFF
4	ON	ON



## Display Offset Function

Normally the count value returns to "0" after resetting, but with this function, the initial value can be set to any desired value.

## Hold Function

When "hold" is input, the counter holds the current count value in memory. Next, when the count value is read into a PLC which uses serial or BCD output, etc., the count value that was held can be read in, even if there is a time lag.

## Setting the Tolerances of Preset Values

In the current model CEU1, the preset value tolerances could only be set as  $\pm$ , but now it has become possible to set an upper and lower limit of  $+ \bigcirc$  mm and  $- \triangle$  mm.

By including preset tolerance setting, superior performance is exhibited in parts inspections, etc. In a workpiece to be measured, there are tolerances which assure a good product. For example, in the case of  $10^{+0.05}_{-0.02}$ , the CEU5 allows these tolerances to be input as they stand. If the workpiece is within tolerances the OK signal is sent.

<Simple input as per drawing dimensions> Tolerances can be set with the preset value. OK/NG signal is output by the counter. Labor savings can be realized in parts inspections.

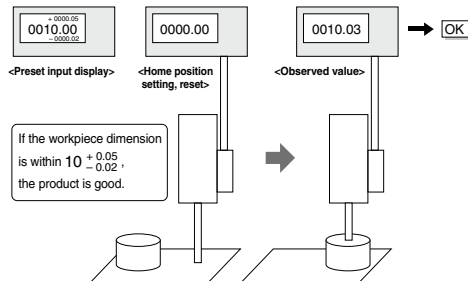

## Count Value Protection

In the past, the count value returned to "0" when the power supply was cut off, but this function holds the previous value even after a power failure. This function can be switched between active and inactive settings.

## Cylinder Stop Output

When workpiece discrimination is performed using a preset counter, it has been common to estimate the amount of time from the cylinder's start of operation until it touches the workpiece and stops, using a timer to read the output after a fixed amount of time. Since cylinder stop output is now output when there is no cylinder movement for a fixed amount of time, timing of preset output and external output, etc. is simplified.

CEP1

CE1

CE2

ML2B

D-□

-X□